

P4 PELLET

PELLET BOILER

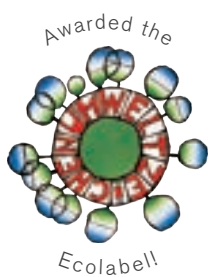

BETTER HEATING

INNOVATIVE AND
COMFORTABLE

froling 



ENVIRONMENTALLY
RESPONSIBLE HEATING,
ECONOMICALLY ATTRACTIVE



The price changes for different energy sources in recent years show the benefits of wood pellets: the ecological way of heating is also economically attractive. Wood is a renewable energy source that is also CO₂-neutral. Pellets are made of natural wood. The large volumes of wood shavings and sawdust generated by the wood-processing

industry are compacted and pelleted without being treated beforehand. Pellets have a high energy output and are easy to deliver and store. These are just some of the advantages that make pellets the perfect fuel for fully automatic heating systems. Pellets are delivered by tanker and unloaded directly into your store.

For almost sixty years Froling has specialised in the efficient use of wood as a source of energy. Today the name Froling stands for modern biomass heating technology. Froling firewood, wood chip and pellet boilers are successfully in operation all over Europe. All of our products are manufactured in our factories in Austria and Germany. Froling's extensive service network ensures that we can handle all enquiries quickly.

GUARANTEED QUALITY AND RELIABILITY FROM AUSTRIA

- International pioneer in technology and design
- Sophisticated fully automatic operation
- Excellent environmental compatibility
- Environmentally responsible energy efficiency
- Renewable and CO₂-neutral fuel
- Ideal for all types of house

With its fully automatic mode of operation, the Froling P4 pellet offers perfect comfort. With its wide range of services, the P4 Pellet can be used in low-energy houses as well as in objects that require more heat. The intelligent control management Lambdatronic P 3200 takes over all control functions and ensures optimal combustion.

The Froling P4 pellet boiler was awarded the „**Plus X Award**“ for high-quality innovations that simplify life, make it more pleasant and at the same time make ecological sense.



MULTI-AWARD WINNING PRODUCTS

Austrian Ecolabel

The Froling P4 Pellet boiler has won many international quality awards in Europe and the USA. Probably the most prestigious of all is the Austrian Ecolabel, describing itself as the world's first environmental award for products and services.

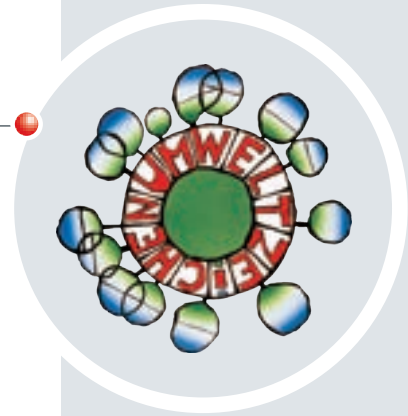

Modern biomass boilers are future-oriented and economical. This is also guaranteed by the many international standards on emissions and efficiency. In Austria the limit values are set by Article 15a of the Federal Constitution (B-VG) and in Germany they are set by the Federal Emissions Control Act passed at the start of 2010 (and implemented in the Federal Emissions Control Ordinance (BImSchV)).

Plus X Award International



Innovation Award at „Bois Energie“ 2008 France



VESTA Award USA



New Product of the Show Award Ireland



FROM LOW-ENERGY HOUSES TO APARTMENT BLOCKS

When it comes to determining heating requirements, the heated living space and the type of construction are the most important factors. The P4 Pellet is available in ten different sizes, and with its wide output range and modulating operation it can be used in both low-energy houses and in buildings with greater heating requirements. It can also be connected to an existing heating system. The Froling Lambdatronic P 3200 smart control management system takes charge of all control functions, including remote control via PC or mobile phone.

Automatic ash removal
P4 Pellet 48/60/80/100/105



Automatic ash removal

With automatic ash removal the ash is fed into two external ash containers. The clever locking mechanism makes it quick and easy to remove the ash container.

PELLETS BOILER P4 PELLET

7" touch display for easy and intuitive operation

Multi-layer insulation

WOS system Efficiency Optimisation System

Patented multiple-pass heat exchanger

Automatic ash removal
in two closed ash containers

Insulated cleaning port door
for excellent heat retention

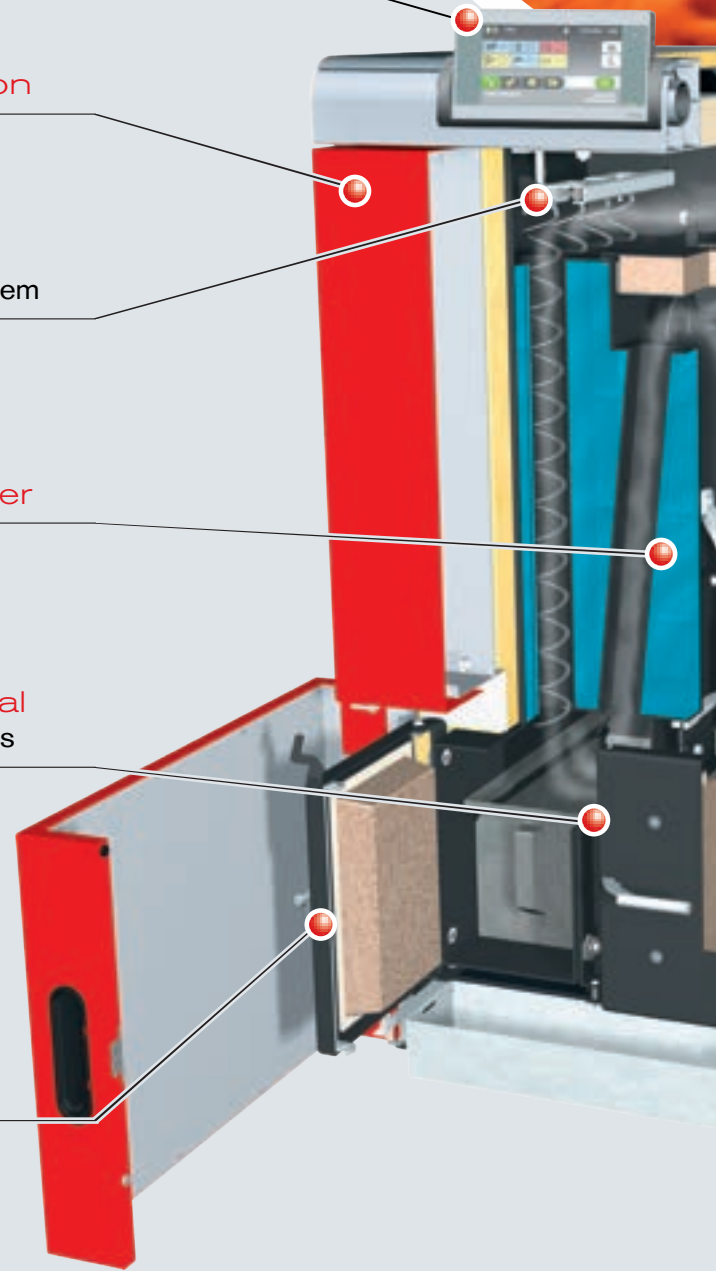
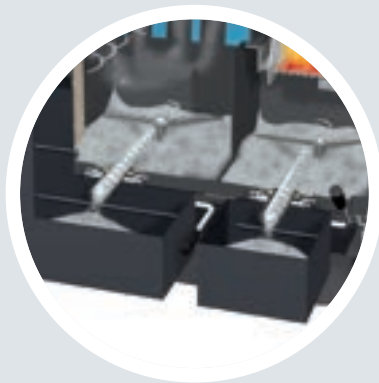

THE LATEST TECHNOLOGY

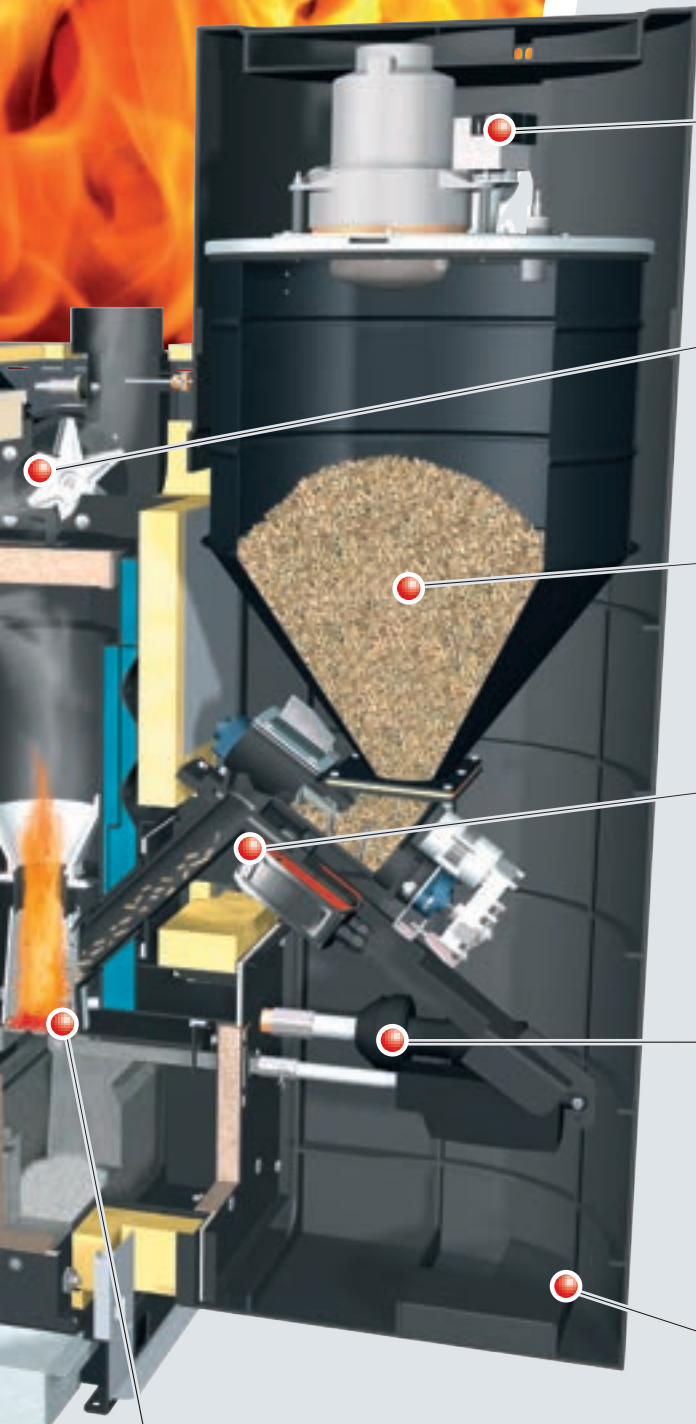

Store gate valve

Speed-regulated, low-noise induced draught fan with function monitoring

Large pellet container with automatic pellet feed and integrated soundproofing (volume 90 - 280 litres)

Proven burner gate valve

Automatic ignition with hot-air blower

Special suction cyclone with integrated soundproofing

Automatic sliding grate for ash removal, offering maintenance-free operation

PERFECTION IN THE DETAILS

Easy to clean

With the P4 Pellet you are choosing a quality product. The automatic sliding grate allows for convenient and maintenance-free operation. Ash is always generated when wood or pellets are burnt. In the P4 Pellet it is transported automatically to two ash containers, which can be emptied simply and easily.

- Advantages:
- Clean combustion
 - Very low emissions
 - Automatic ash removal



Plug and Play

The P4 Pellet offers important advantages even before it reaches your boiler room. Its compact design makes it child's play to install the P4 Pellet even in confined spaces. All components are already fully wired. But if necessary, individual components can be removed in just a few steps. The parts can then be positioned separately. This means that the P4 Pellet is also an excellent choice for renovated systems.

- Advantages:
- Quiet operation
 - Compact design
 - Easy positioning



Also ideal for container installation

The Froling Energy box is an all-in-one complete solution. All components are perfectly matched to each other.

- Advantages:
- Relocation of the boiler room and store
 - All-in-one system
 - Perfectly matched components

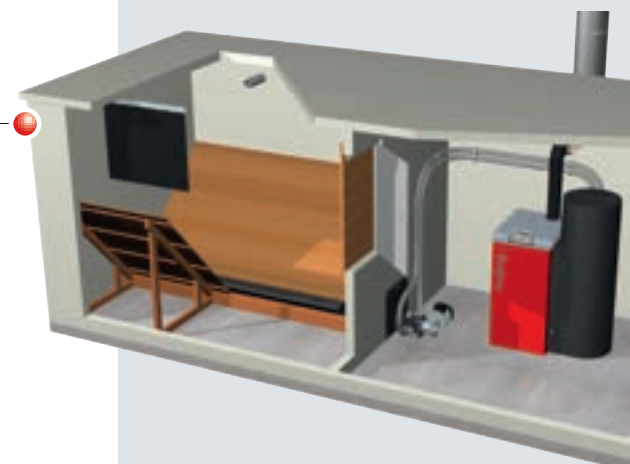

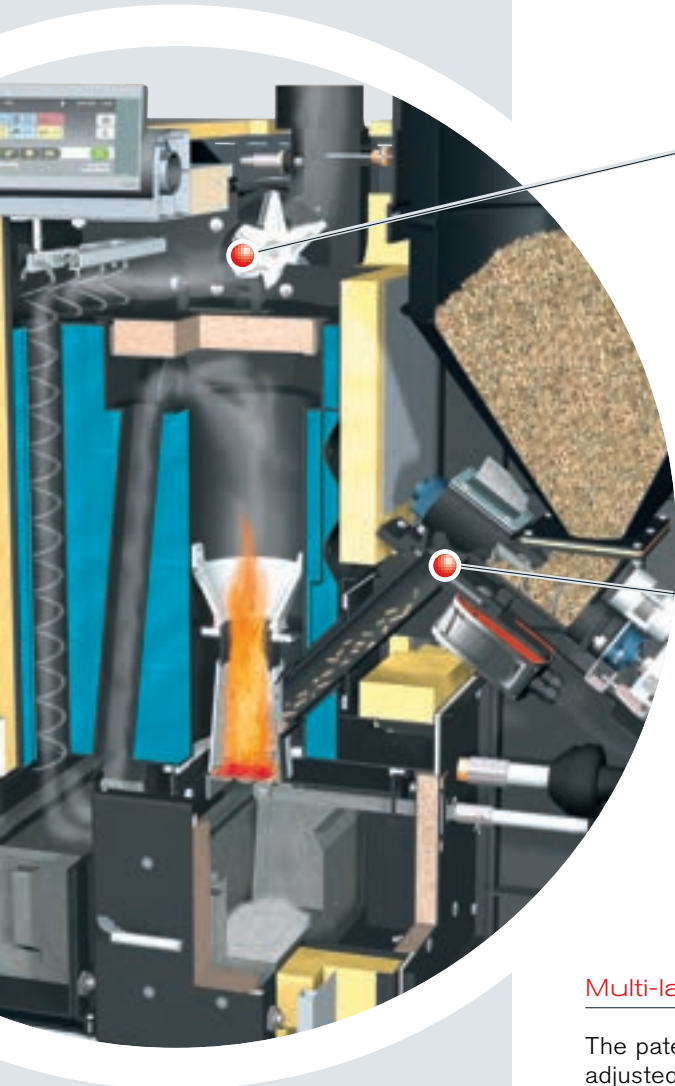

Speed-controlled induced draught fan and lambda control with broadband probe

The speed-regulated induced draught fan, which comes as standard, ensures the exact air quantity for combustion. As the induced draught fan is speed-regulated, it stabilises combustion throughout and adjusts the output to requirements. Working together with the lambda control, it ensures optimum combustion conditions. The induced draught fan also runs very quietly and energy efficiently.

- Advantages:
- Maximum ease of use
 - Constant optimisation of combustion

Comprehensive safety concept

The downpipe – in conjunction with the safety-tested, gate valve-fitted combustion chamber and the gate valve-fitted store – creates a double door system. The self test before the system starts and the automatic diagnostics system support this unique safety concept.

- Advantages:
- The highest possible operating safety
 - Maximum reliability

Multi-layer heat exchanger with 3-pass design

The patented multiple-pass heat exchanger means that operation is perfectly adjusted in every respect with the P4 Pellet. An external return temperature control is not necessary. Together with the variable operation, this results in considerable operating savings. The special boiler construction prevents the temperature from dropping below the dew point and ensures the P4 Pellet has a very long service life. The 3-pass design repeatedly alters the flow of the flue gases in the boiler, ensuring exceptionally efficient ash separation.

- Advantages:
- Maximum boiler use
 - Considerable cost savings
 - Long service life

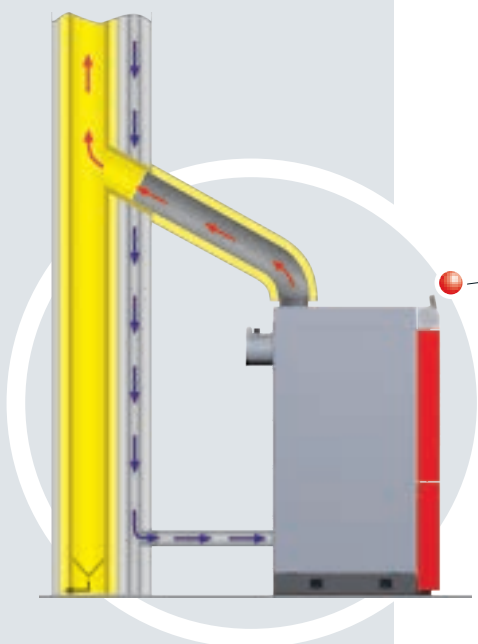

Room-air-independent operation

Low-energy houses have a closed building shell. In traditional boiler rooms there can be uncontrolled heat loss from the necessary ventilation openings. This is avoided with room air-independent boilers because of the direct air connection. Also the temperature of the combustion air that is supplied is raised with an integrated pre-heating system, increasing the efficiency of the boiler.

- Advantages:
- Perfectly suited for low-energy houses
 - The highest possible system efficiency

4 probe manual suction system

The RS 4 manual pellet suction system creates more space in your fuel store. Thanks to the fact that the suction probes are flexible in terms of location, it is possible to make optimal use of every room shape. The switchover between suction probes is manual. Rule of thumb: Plan for one suction probe for every 1 m² pellet storage area.

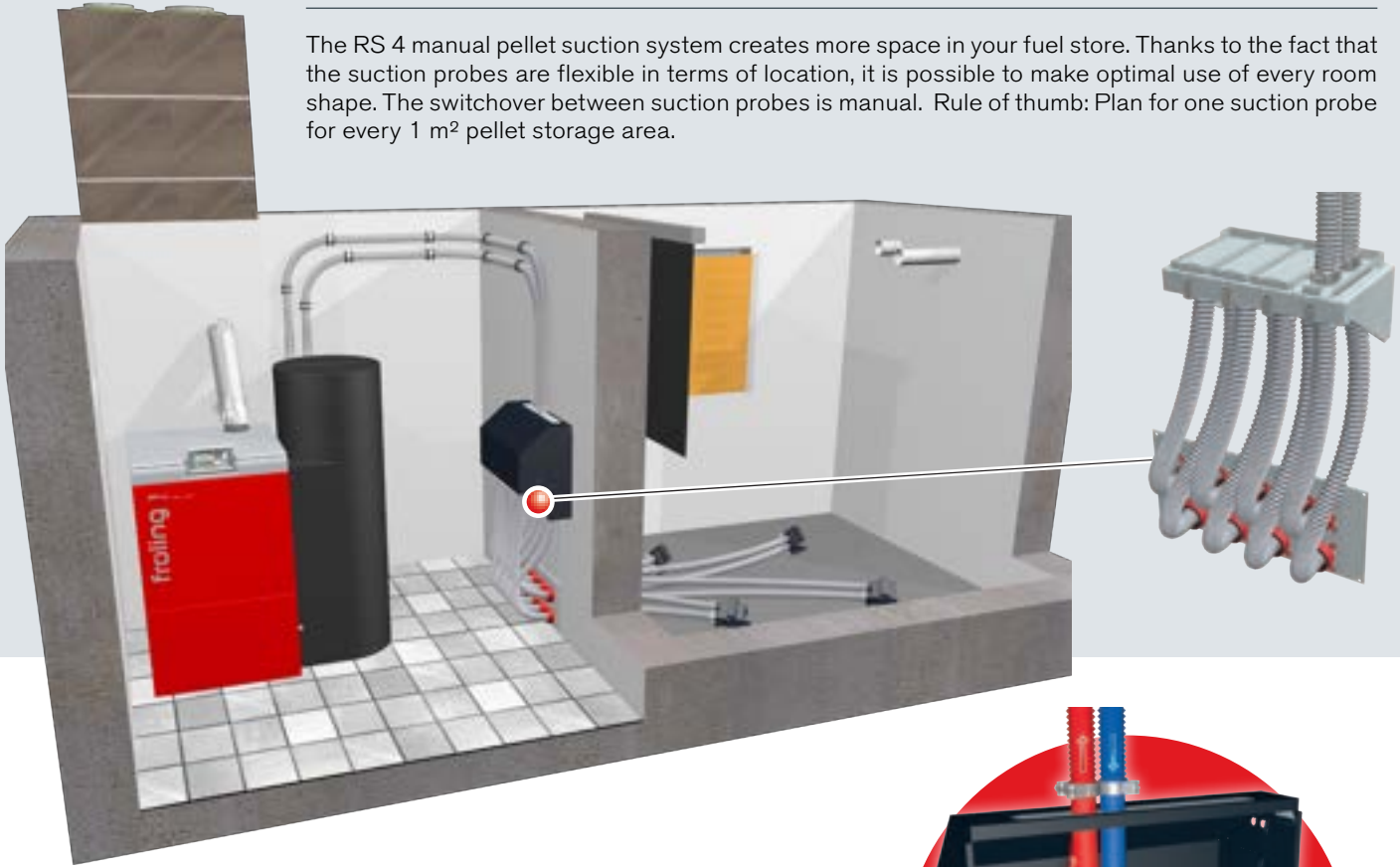

Pellet filler pipes

The pellets are delivered by tanker and blown into the store through a filling pipe. The second pipe is used for controlled and dust free removal of the escaping air.

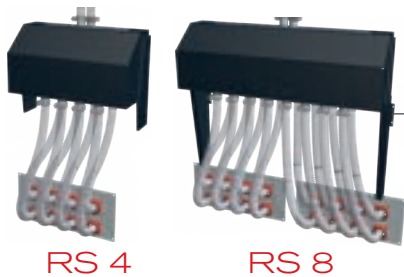
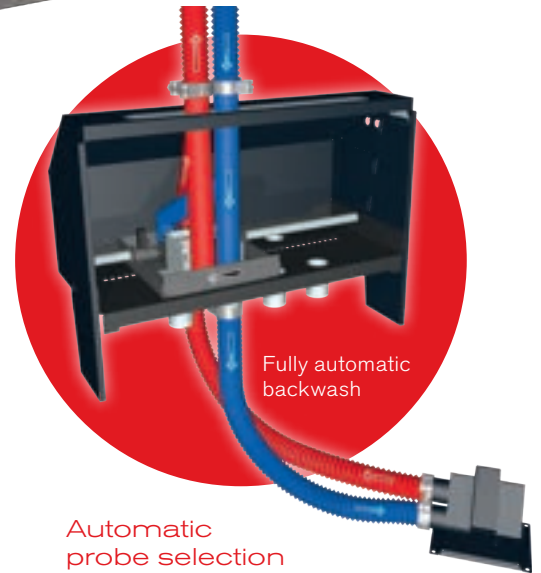

Pellet suction system RS 4 / RS 8

Design as above, however with the difference of automatic switchover between the suction probes.

Automatic probe selection

It automatically selects 4 or 8 suction probes in specified cycles, it is controlled by the pellet boiler. If, however, the suction probe fails unexpectedly, it is remedied by a fully automatic reversal of the air supply (back flushing).

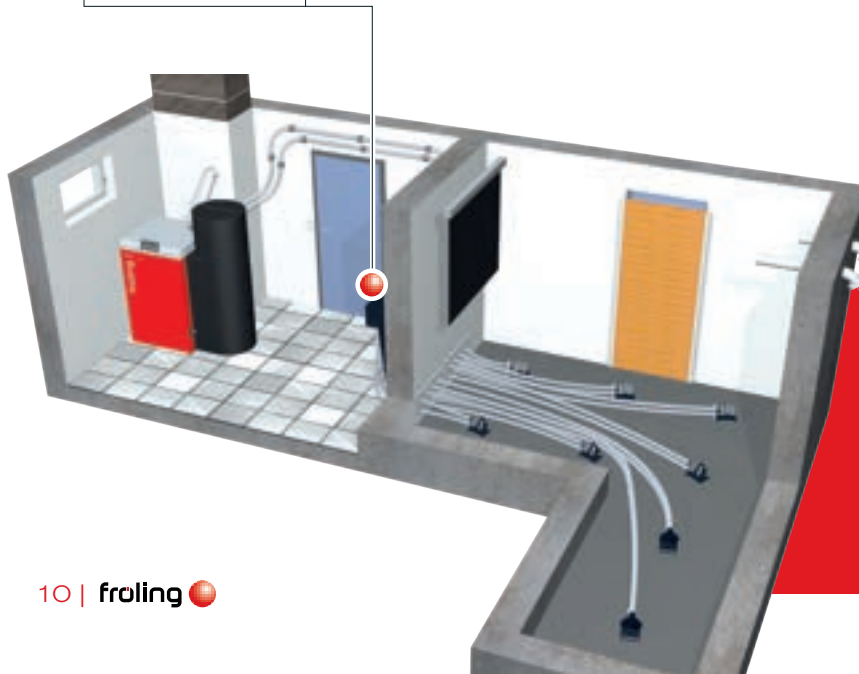

Pyramid for fuel store optimisation

Advantages at a glance:

- easy to assemble
- no sloping slides necessary in the bunker
- more store space (30%)
- automatic switching between the probes
- automatic back flushing
- maintenance-free system

More information can be found on the Froeling brochure "Discharge systems for pellets"

Bag silo

The bag silo system is a flexible, simple way of storing pellets. Available in 9 different footprints (from 1.5 m x 1.25 m to 2.9 m x 2.9 m) with a capacity of between 1.6 and 7.4 tonnes, depending on the bulk density. There are other advantages to using a bag silo. It is easy to assemble and dustproof. You can also fit rainproof and sunproof covers and install the silo outside.

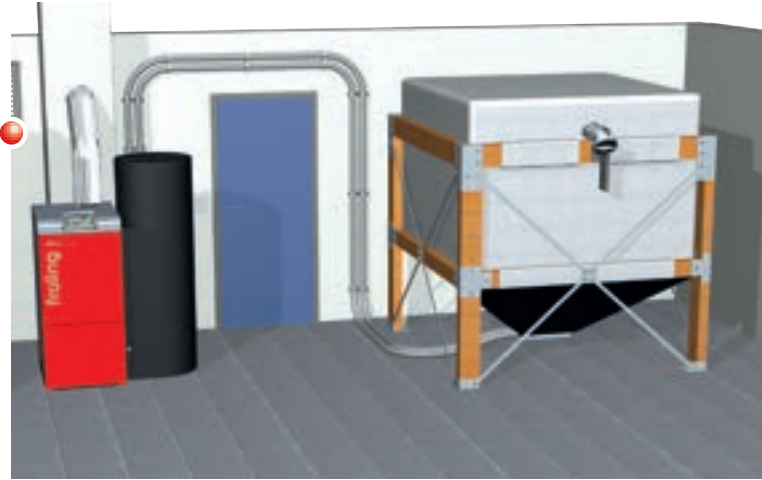

Suction screw system

The Froeling screw suction system is the ideal solution for rectangular rooms with front-end removal. The deep and horizontal position of the discharge screw means the space in the room is used optimally and complete emptying of the store is guaranteed. Combined with a suction system from Froeling it also enables flexible boiler installation.



1-2-3 suction screw system

The 1-2-3 suction screw system from Froeling is the ideal solution for large stores. Depending on the size of the store, two or three discharge screws are positioned parallel to each other and integrated into the fuel feed of the suction system. The automatic screw selector automatically switches between the suction screws in a predefined cycle, ensuring that the store is emptied evenly.

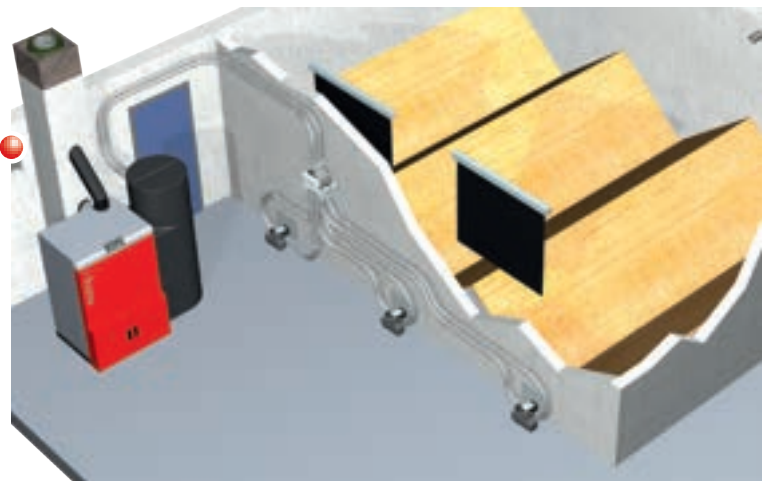

Pellet Mole®

This pellet discharge system is easy to install and makes full use of the store space. The Pellet Mole® draws the pellets from above, ensuring an optimum fuel feed to the boiler. The Pellet Mole moves automatically into every corner of the store to empty it as efficiently as possible.



Pellet Mole E3®

The E3 is designed for larger pellet plants with boiler outputs from 40 to 300 kW and an annual pellet demand of several hundred tonnes. The typical storage sizes are up to 40 tons or 60 m3 capacity. The star-shaped Round brushes made of high-loadable polyamide dose the pellet gently before the suction port and move the E3 smoothly over the pellet supply.

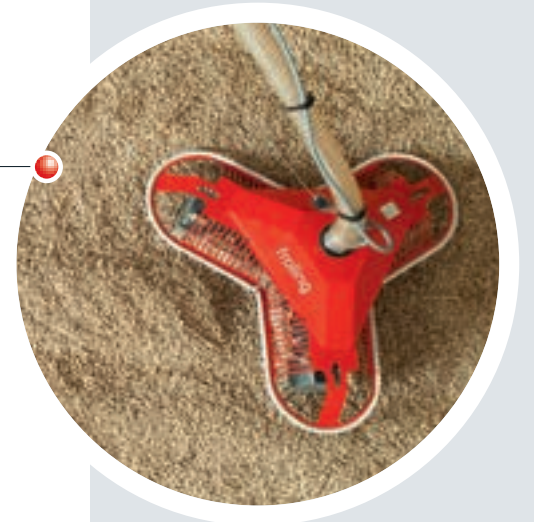

Option: Fuel tuning with the PST pellet deduster

Wood pellets are clean and of very high quality. Any remaining wood dust can be filtered from the fuel using the PST pellet deduster. This optimises the efficiency of the combustion zone over the years. The PST pellet deduster can be fitted in any position in the return air line of the pellet suction system.

The suction cyclone design means that the dust particles are separated from the return air and deposited internally. The container is convenient to remove and transport to the emptying point. The system can be retro-fitted at any time and it is maintenance-free.

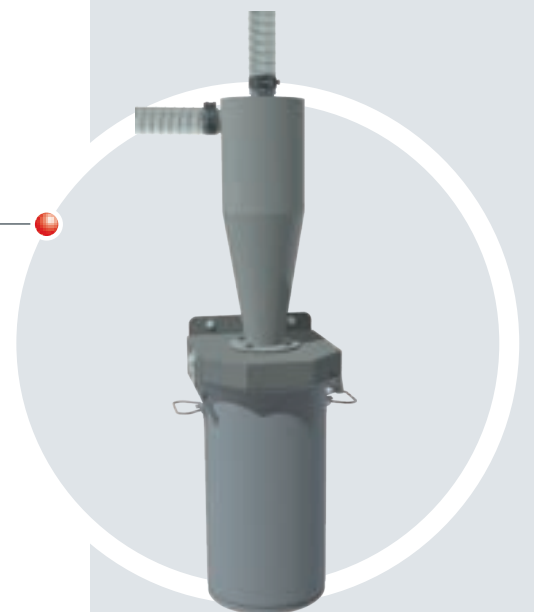

CONDENSING TECHNOLOGY FOR PELLET BOILERS

For outputs from 15 to 60 kW, the Froling P4 Pellet boiler is also available with innovative condensing boiler technology. The flue gas contains energy, which escapes unused up the chimney with conventional solutions, but an additional heat exchanger positioned on the back of the boiler makes use of it for the heating system. This leads to more efficient operation and higher efficiencies. Froling won the innovation prize at the ExpoEnergy trade fair in Wels for condensing boiler technology in the biomass sector as early as 1996, making it a pioneer in the field. The heat exchanger is made of high-quality stainless steel. It is cleaned using a water flushing system. The module can also be retrofitted.



Advantages:

- Lower fuel costs
- Filtration of the flue gas
- Reduced emissions
- Automatic cleaning
- The condensing module can also be retrofitted at any time

Requirements for optimal use of condensing technology:

- The return temperature should be as low as possible (e.g. floor or wall heating)
- Moisture-resistant and soot-fire-resistant exhaust system (W3G approval)
- Duct connection for condensate drainage and drainage of the rinse water

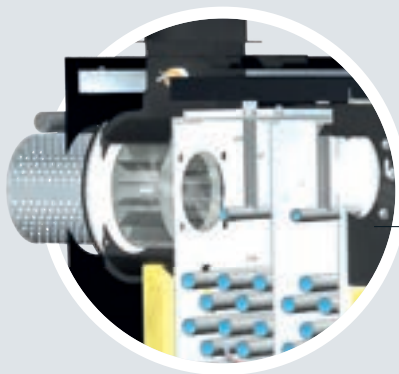

Automatic rinsing device

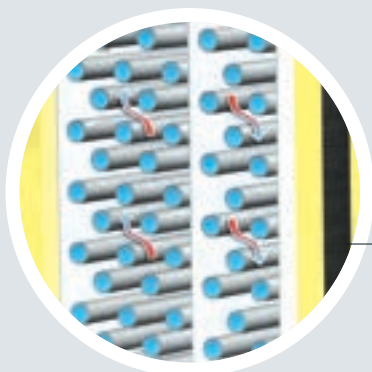

Heat exchanger made of stainless steel

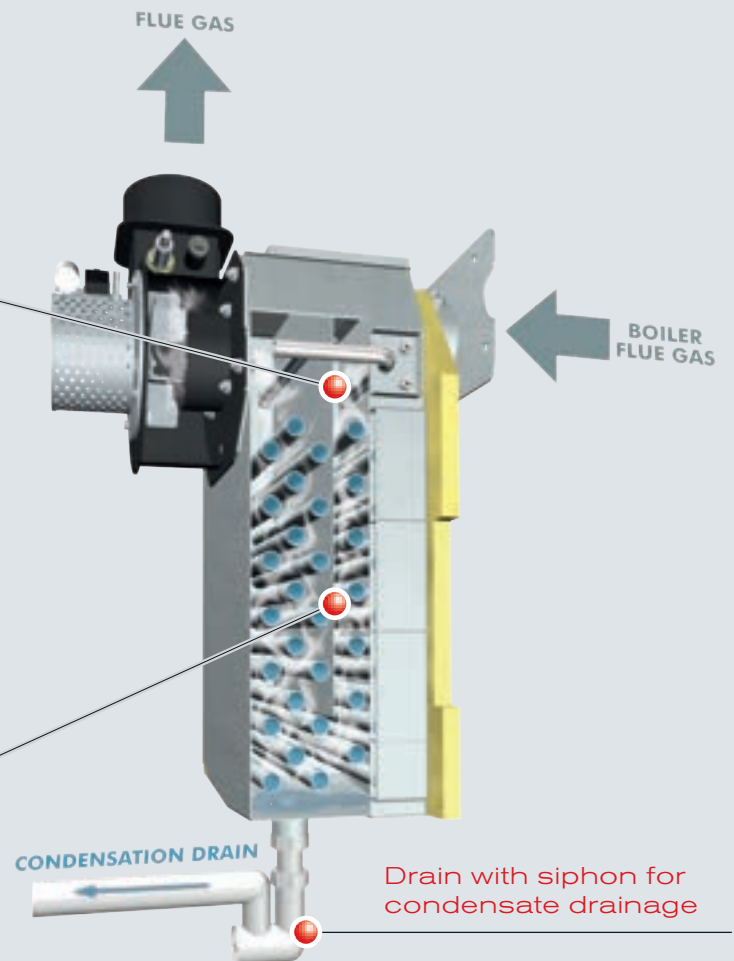

Drain with siphon for condensate drainage

INDIVIDUAL CONTROL UNIT OF THE HEATING SYSTEM

Lambdatronic P 3200 control unit

Fröling provides a future-oriented Lambdatronic P 3200 and a new 7" touch display. Intelligent control management makes it possible to connect up to 18 heating circuits, up to 4 storage tanks and up to 8 hot water storage tanks. The control unit ensures that the operating statuses are clearly shown. The menu structure is ideally organised to allow easy operation. All essential functions can be selected by simply pressing icons on the large colour display.

- Advantages:
- Precise combustion control by a Lambda control using a Lambda probe
 - Connection for up to 18 heating circuits, 8 water heaters and up to 4 storage tank management systems
 - Integration capability for a solar panel system
 - LED frame for status display with illuminated presence detection
 - Simple and intuitive operation
 - Various smart home options (such as Loxone)
 - Remote control from the living room (remote control 3200 and RGB 3200 Touch) or via Internet (froeling-connect.com)



SIMPLE & INTUITIVE OPERATION



Fig. 1 General overview of the heating circuit (start screen)



Fig. 2 View of the heating times (individually adjustable)



Fig. 3 Overview of the new holiday mode



KEEP TRACK OF EVERYTHING WITH THE FROLING APP

The Froling App allows you to check and control your Froling boiler online from anywhere, at any time. You can read and modify the main status information and settings easily and conveniently online. You can also specify which status messages you want to be informed about via SMS or e-mail (e.g. when the ash box is to be emptied or in the event of a fault message).

Froling boiler (software core module from version V50.04 B05.16) with boiler touch display (from version V60.01 B01.34) a broadband internet connection and a tablet/smartphone with iOS or Android operating system are required. Once the boiler has been connected to the internet and activated, the system can be accessed 24/7 from anywhere using a web-enabled device (mobile, tablet, PC, etc.). The app is available in the Android Play Store and iOS App Store.

NEW! Desktop version
with even more options.



- Simple and intuitive operation of the boiler
- Status information can be called up and changed within seconds
- Individual naming of the heating circuits
- Changes of status are notified directly to the user (e.g. via e-mail or push notifications)
- No additional hardware required (such as an Internet gateway)

SMART HOME

Enjoy smart, convenient and piece-of-mind living with the Smart Home connection options from Froling.

Loxone

Combine your Froling heating system with the Loxone Miniserver and the new Froling Extension and implement individual boiler control on the basis of the single room control of the Loxone Smart Home.

Advantages: Easy operation and viewing of the heating circuit via the Loxone Miniserver, immediate notification of status changes and individual operating modes for each situation (presence, holiday, economy mode, etc.)

Modbus

Via the Froling modbus interface, the system can be integrated into a building management system.



ACCESSORIES FOR EVEN GREATER CONVENIENCE

FRA room temperature sensor

By using the FRA room temperature sensor, sized just 8x8 cm, the main modes of the corresponding heating circuit can be easily selected and adjusted. The FRA can be connected both with and without affecting the store. The adjusting wheel allows you to change the room temperature by up to $\pm 3^{\circ}\text{C}$.



RBG 3200 room console

For even more convenience you can use the RBG 3200 room console and the new RBG 3200 Touch. You can control the heating system easily from your living room. Important system data is clearly displayed and settings can be changed at the push of a button.



RBG 3200 Touch room console

The RBG 3200 Touch has an impressive touchpad interface. The menu structure means it is intuitive and easy to use. The 17x10 cm console with colour screen shows the most important functions at a glance and automatically adjusts the background lighting to the conditions. The room consoles are connected to the boiler controller using a bus cable.



Heating circuit module

With wall casing and one contact sensor as heating circuit control for up to two mixer heating circuits.



Hydraulic module

With wall casing and two immersion sensors to control one or two pumps and one isolating valve with up to six sensors.



WMZ solar package kit

Set for measuring heat quantity, consisting of a volume pulse transmitter ETW-S 2.5, a collector sensor and two contact sensors for recording flow and return temperatures.

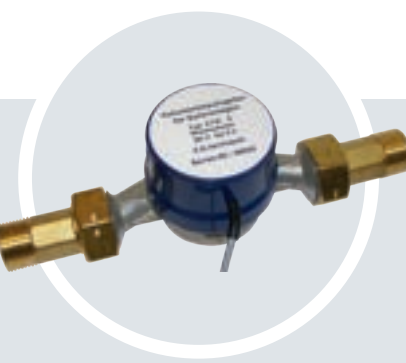

Froeling systems engineering offers efficient energy management. Up to 4 storage tanks, 8 hot water tanks and 18 heating circuits can help manage the heating. You can also benefit from the ability to integrate other means of energy production such as solar panel systems.

- Vorteile:
- Complete solutions for all requirements
 - The components work perfectly together
 - Integrated solar power

SYSTEMS ENGINEERING FOR OPTIMUM ENERGY CONSUMPTION

P4 Pellet with S3 Turbo, layered tank and Unicell NT-S

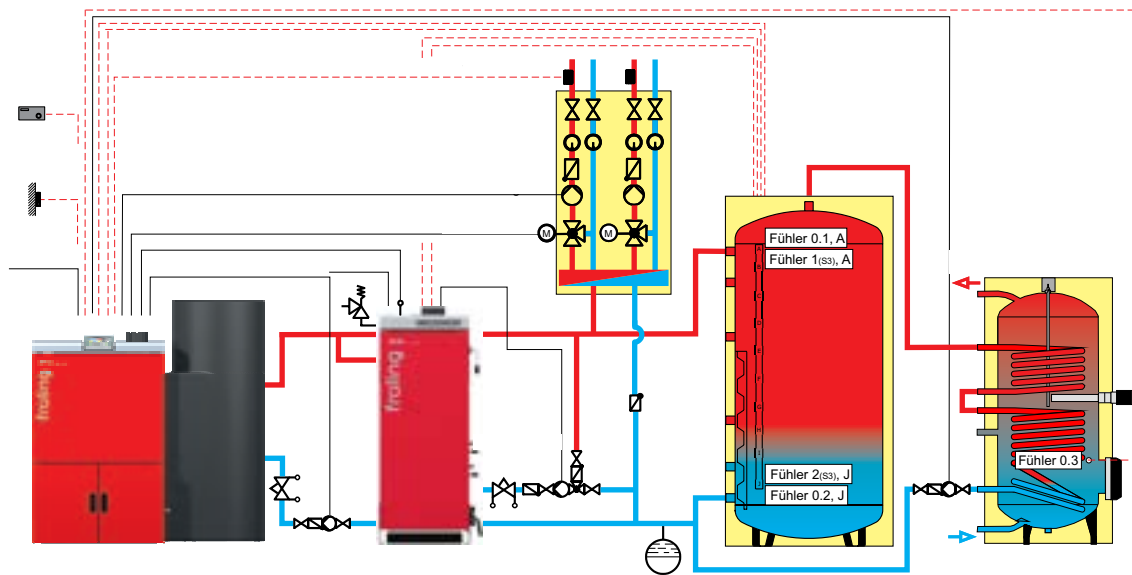

P4 Pellet with Unicell NT-S

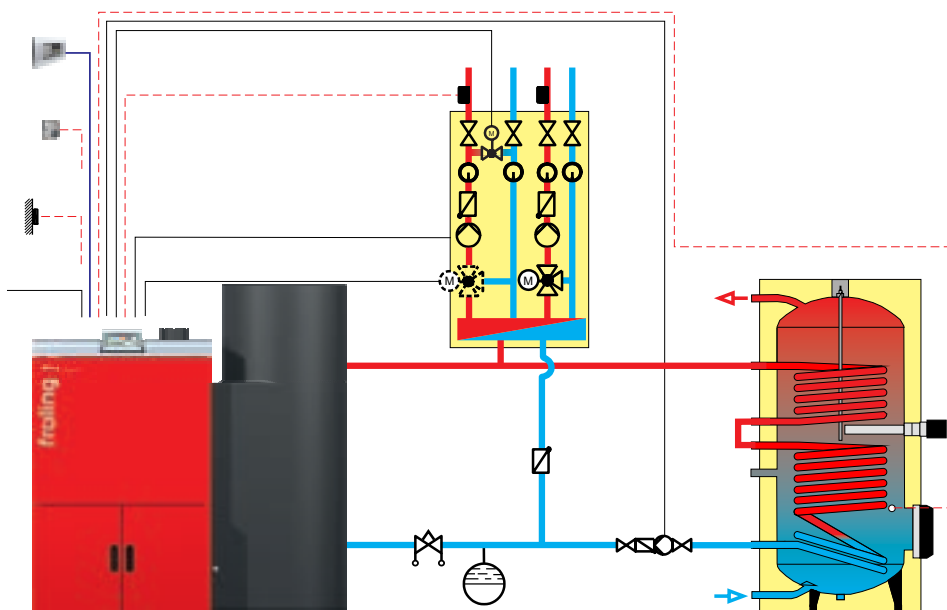

WMZ solar package (optional)

The heat quantity measurement package (WMZ) enables you to benchmark the efficiency of your solar panel system. The Lambdatronic P3200 analyses and displays the flow and return temperature, the flow rate and the daily and total output of the solar panel system. With variable operation the Froling P4 Pellet is only heated to the temperature level required by the heating system (hot water tank, radiator heating circuit). This avoids unnecessary radiant heat loss. This special feature guarantees maximum efficiency and avoids the need for an external return temperature control.

Advantages: • Minimal radiant heat loss • Maximum efficiency • No external return temperature control required

P4 Pellet with H3 hygienic tank and link to solar panel system

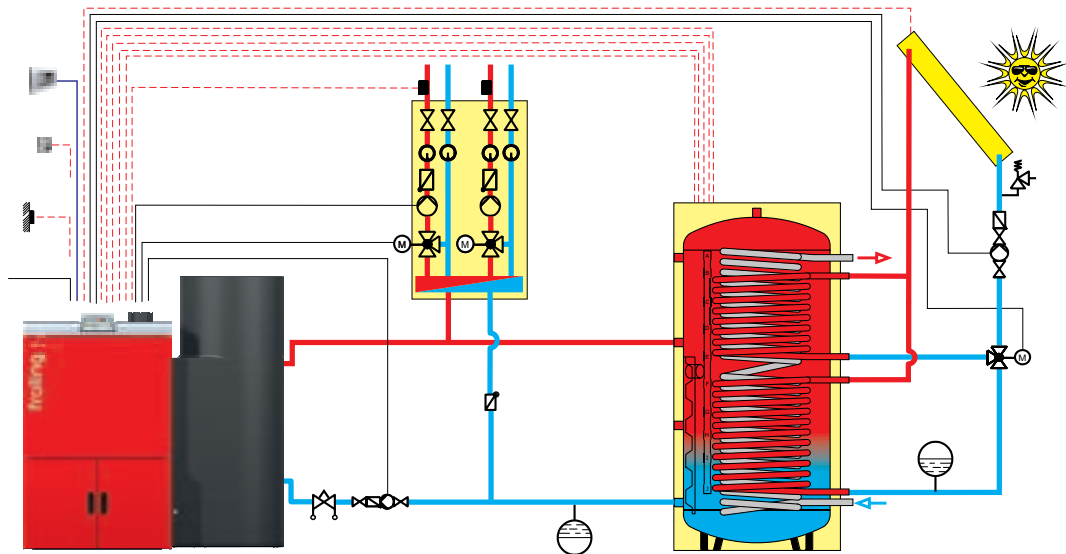

Froling cascade controller

Heating requirements vary considerably, especially in larger buildings such as hotels or public buildings. Froling offers a flexible answer to this problem in the form of a cascade. This smart solution allows you to combine up to four P4 Pellet boilers to reach a total output of up to 420 kW. You can also see the benefits of a cascade during the summer months. If the heat requirement is low, one boiler is often sufficient for hot water preparation. This provides a particularly efficient and economical heating solution. A further advantage is the increased reliability of operation, as the heat is provided by several boilers.

Two interconnecting P4 Pellet boilers with layered tank

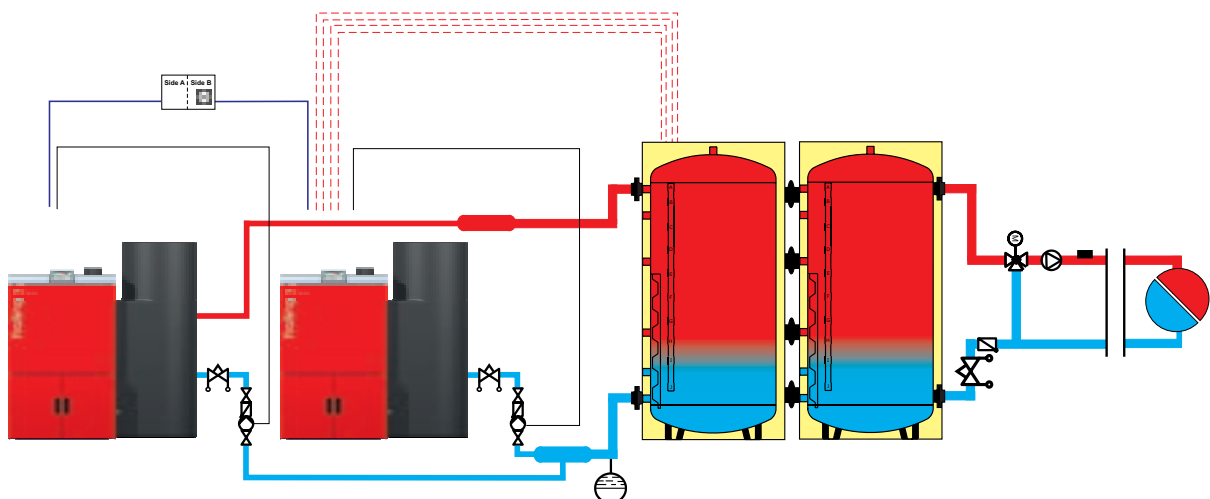

Three P4 Pellet boilers with layered tank

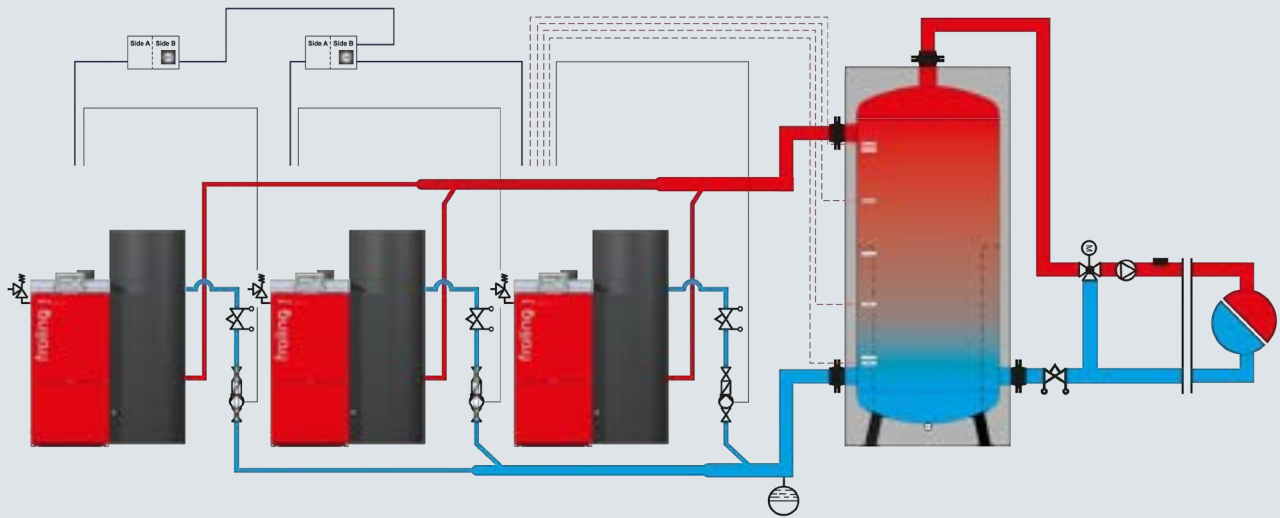

OPERATING AND MAINTENANCE AREAS

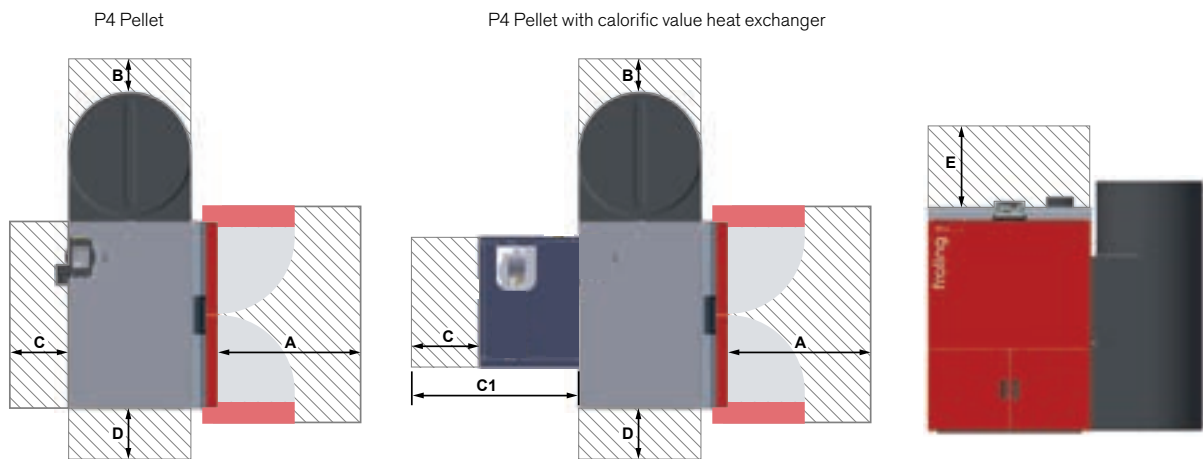

Minimum distances - P4 Pellet [mm]	48-60	80-100
A Space for insulated door	490	590
B Minimum distance to stoker assembly		300
C Distance between rear of boiler and wall		300
D Distance between side of boiler and wall		200
E Maintenance area above the boiler for removing the WOS springs upwards		500
Minimum room height	2100	2200

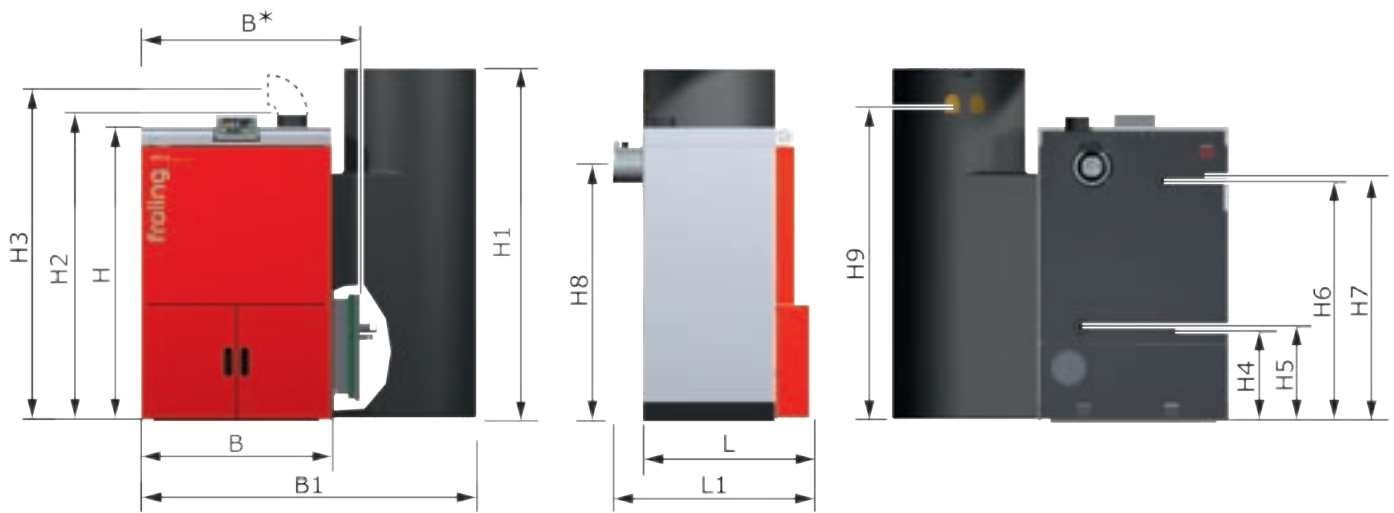

Dimensions - P4 Pellet [mm]	48	60	80	100	105
L Length of boiler	900 ¹⁾	900 ¹⁾	1000 ²⁾	1000 ²⁾	1000 ²⁾
L1 Total length including induced draught fan	1100	1100	1070	1070	1070
B Width of boiler	1030	1030	1235	1235	1235
B* Width of boiler including support	1275	1275	1480	1480	1480
B1 Total width including suction cyclone	1790	1790	2085	2085	2085
H Height of boiler	1585	1585	1710	1710	1710
H1 Total height including suction cyclone	1900	1900	1900	1900	1900
H2 Height of flue pipe connection	1685	1685	1785	1785	1785
H3 Height of flue gas pipe connection ³⁾	1790	1790	-	-	-
H4 Height of drainage connection	490	490	500	500	500
H5 Height of return connection	515	515	520	520	520
H6 Height of flow connection	1290	1290	1410	1410	1410
H7 Height of ventilation connection	1310	1310	1430	1430	1430
H8 Height of ID fan connection	1375	1375	1495	1495	1495
H9 Height of suction system connection	1720	1720	1720	1720	1720
Flue pipe diameter	150	150	200	200	200

¹⁾ You can reduce the size to 780 mm by removing the control (e.g. to fit through a door with a clearance of 800 mm)

²⁾ You can reduce the size to 880 mm by removing the control (e.g. to fit through a door with a clearance of 900 mm)

³⁾ When using the optional flue pipe nozzle for low chimney connections

Technical specifications - P4 Pellet	48	60	80	100	105
Rated heat output [kW]	48	58,5	80	100	105
Output range [kW]	14,4 - 48	17,6 - 58,5	24 - 80	30 - 100	31,5 - 105
Energy (ErP) label*	A ⁺	A ⁺			
Power consumption [W]	114	119	115	112	112
Water capacity [l]	170	170	280	280	280
Boiler weight [kg]	760	760	1090	1100	1110
Capacity, pellet hopper [l]	200	200	280	280	280
Capacity, ash container left/right [l]	33/33				

* Composite label (boiler + controls)

The ecodesign requirements according to VO (EU) 2015/1189, Annex II, point 1. are met.

Your Froling partner

Froeling Heizkessel- und Behälterbau Ges.m.b.H.

A-4710 Grieskirchen, Industriestr. 12

AT: Tel +43 (0) 7248 606-0

Fax +43 (0) 7248 606-600

DE: Tel +49 (0) 89 927 926-0

Fax +49 (0) 89 927 926-219

E-mail: info@froeling.com

Web: www.froeling.com